

870

600

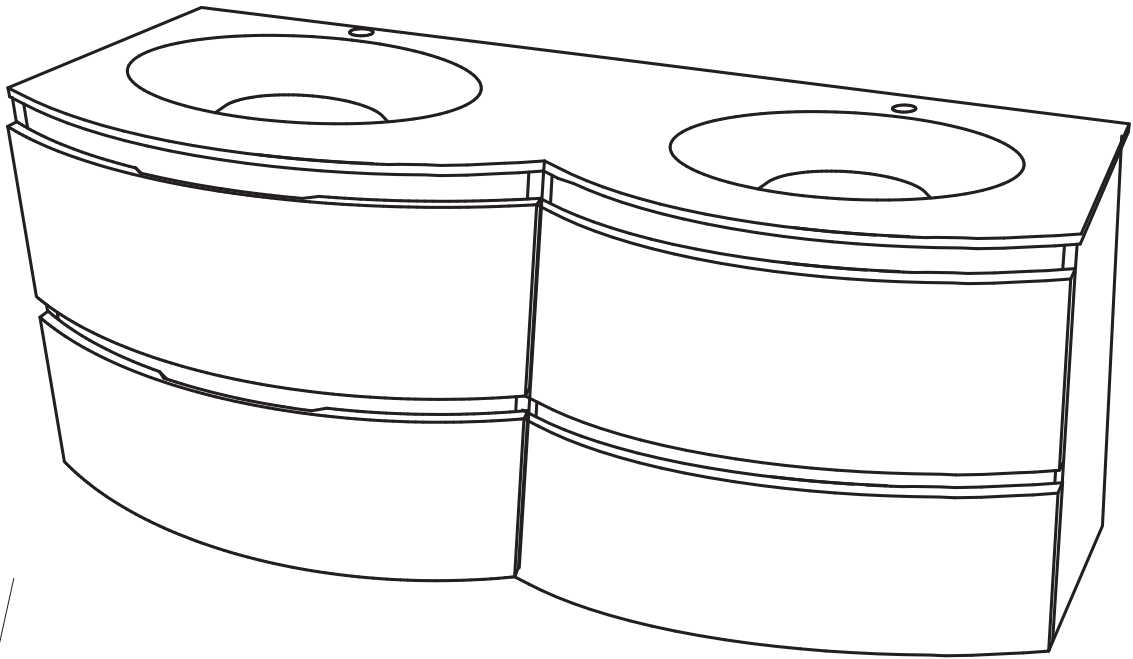

580

490

1400